



SEMiX® 5

3-Level NPC IGBT-Module

Engineering Sample

SEMiX205MLI12E4

Target Data

Features

- Solderless assembling solution with PressFIT signal pins and screw power terminals
- IGBT 4 Trench Gate Technology
- $V_{CE(sat)}$ with positive temperature coefficient
- Low inductance case
- Reliable mechanical design with injection moulded terminals and reliable internal connections
- UL recognized file no. E63532
- NTC temperature sensor inside

Remarks*

- Case temperature limited to $T_c=125^\circ\text{C}$ max.
- Product reliability results are valid for $T_{jop}=150^\circ\text{C}$
- IGBT1: outer IGBTs T1 & T4
- IGBT2: inner IGBTs T2 & T3
- Diode1: outer diodes D1 & D4
- Diode2: inner diodes D2 & D3
- Diode5: clamping diodes D5 & D6
- For storage and case temperature with TIM see document "TP(HALA P8) SEMiX 5p"

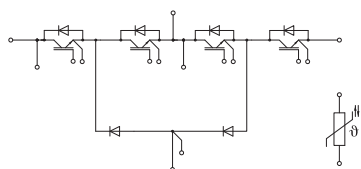

MLI

Absolute Maximum Ratings			
Symbol	Conditions	Values	Unit
IGBT1			
V_{CES}	$T_j = 25^\circ\text{C}$	1200	V
I_C	$T_j = 175^\circ\text{C}$	$T_c = 25^\circ\text{C}$	313
		$T_c = 80^\circ\text{C}$	241
I_{Cnom}		200	A
I_{CRM}	$I_{CRM} = 3 \times I_{Cnom}$	600	A
V_{GES}		-20 ... 20	V
t_{psc}	$V_{CC} = 800\text{ V}, V_{GE} \leq 15\text{ V}, T_j = 150^\circ\text{C}, V_{CES} \leq 1200\text{ V}$	10	μs
T_j		-40 ... 175	$^\circ\text{C}$
IGBT2			
V_{CES}	$T_j = 25^\circ\text{C}$	1200	V
I_C	$T_j = 175^\circ\text{C}$	$T_c = 25^\circ\text{C}$	290
		$T_c = 80^\circ\text{C}$	223
I_{Cnom}		200	A
I_{CRM}	$I_{CRM} = 3 \times I_{Cnom}$	600	A
V_{GES}		-20 ... 20	V
t_{psc}	$V_{CC} = 800\text{ V}, V_{GE} \leq 15\text{ V}, T_j = 150^\circ\text{C}, V_{CES} \leq 1200\text{ V}$	10	μs
T_j		-40 ... 175	$^\circ\text{C}$
Diode1			
V_{RRM}	$T_j = 25^\circ\text{C}$	1200	V
I_F	$T_j = 175^\circ\text{C}$	$T_c = 25^\circ\text{C}$	229
		$T_c = 80^\circ\text{C}$	172
I_{Fnom}		200	A
I_{FRM}	$I_{FRM} = 2 \times I_{Fnom}$	400	A
I_{FSM}	10 ms, sin 180°, $T_j = 25^\circ\text{C}$	990	A
T_j		-40 ... 175	$^\circ\text{C}$
Diode2			
V_{RRM}	$T_j = 25^\circ\text{C}$	1200	V
I_F	$T_j = 175^\circ\text{C}$	$T_c = 25^\circ\text{C}$	214
		$T_c = 80^\circ\text{C}$	160
I_{Fnom}		200	A
I_{FRM}	$I_{FRM} = 2 \times I_{Fnom}$	400	A
I_{FSM}	10 ms, sin 180°, $T_j = 25^\circ\text{C}$	990	A
T_j		-40 ... 175	$^\circ\text{C}$
Diode5			
V_{RRM}	$T_j = 25^\circ\text{C}$	1200	V
I_F	$T_j = 175^\circ\text{C}$	$T_c = 25^\circ\text{C}$	219
		$T_c = 80^\circ\text{C}$	163
I_{Fnom}		200	A
I_{FRM}	$I_{FRM} = 2 \times I_{Fnom}$	400	A
I_{FSM}	10 ms, sin 180°, $T_j = 25^\circ\text{C}$	990	A
T_j		-40 ... 175	$^\circ\text{C}$
Module			
$I_{t(RMS)}$		300	A
T_{stg}	module without TIM	-40 ... 125	$^\circ\text{C}$
V_{isol}	AC sinus 50Hz, $t = 1\text{ min}$	4000	V



SEMiX® 5

3-Level NPC IGBT-Module

Engineering Sample

SEMiX205MLI12E4

Target Data

Features

- Solderless assembling solution with PressFIT signal pins and screw power terminals
- IGBT 4 Trench Gate Technology
- $V_{CE(sat)}$ with positive temperature coefficient
- Low inductance case
- Reliable mechanical design with injection moulded terminals and reliable internal connections
- UL recognized file no. E63532
- NTC temperature sensor inside

Remarks*

- Case temperature limited to $T_C=125^\circ\text{C}$ max.
- Product reliability results are valid for $T_{jop}=150^\circ\text{C}$
- IGBT1: outer IGBTs T1 & T4
- IGBT2: inner IGBTs T2 & T3
- Diode1: outer diodes D1 & D4
- Diode2: inner diodes D2 & D3
- Diode5: clamping diodes D5 & D6
- For storage and case temperature with TIM see document "TP(HALA P8) SEMiX 5p"

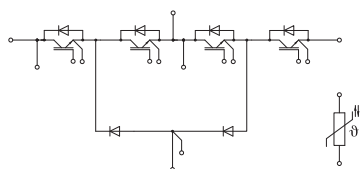

MLI

Characteristics						
Symbol	Conditions		min.	typ.	max.	Unit
IGBT1						
$V_{CE(sat)}$	$I_C = 200\text{ A}$ $V_{GE} = 15\text{ V}$ chipllevel	$T_j = 25^\circ\text{C}$		1.80	2.05	V
		$T_j = 150^\circ\text{C}$		2.20	2.40	V
V_{CE0}	chipllevel	$T_j = 25^\circ\text{C}$		0.80	0.90	V
		$T_j = 150^\circ\text{C}$		0.70	0.80	V
r_{CE}	$V_{GE} = 15\text{ V}$ chipllevel	$T_j = 25^\circ\text{C}$		5.0	5.8	m Ω
		$T_j = 150^\circ\text{C}$		7.5	8.0	m Ω
$V_{GE(th)}$	$V_{GE} = V_{CE}, I_C = 7.6\text{ mA}$		5	5.8	6.5	V
I_{CES}	$V_{GE} = 0\text{ V}, V_{CE} = 1200\text{ V}, T_j = 25^\circ\text{C}$				2.7	mA
C_{ies}	$V_{CE} = 25\text{ V}$ $V_{GE} = 0\text{ V}$	$f = 1\text{ MHz}$		12.3		nF
C_{oes}		$f = 1\text{ MHz}$		0.81		nF
C_{res}		$f = 1\text{ MHz}$		0.69		nF
Q_G	$V_{GE} = -8\text{ V...} + 15\text{ V}$			1130		nC
R_{Gint}	$T_j = 25^\circ\text{C}$			3.8		Ω
$t_{d(on)}$	$V_{CC} = 600\text{ V}$	$T_j = 150^\circ\text{C}$		78		ns
t_r	$I_C = 200\text{ A}$	$T_j = 150^\circ\text{C}$		54		ns
E_{on}	$V_{GE} = +15/-8\text{ V}$	$T_j = 150^\circ\text{C}$		12.8		mJ
$t_{d(off)}$	$R_{G\ on} = 0.5\ \Omega$	$T_j = 150^\circ\text{C}$		490		ns
t_f	$R_{G\ off} = 1\ \Omega$	$T_j = 150^\circ\text{C}$		114		ns
E_{off}	$di/dt_{on} = 3610\text{ A}/\mu\text{s}$ $di/dt_{off} = 1530\text{ A}/\mu\text{s}$ $du/dt = 3530\text{ V}/\mu\text{s}$	$T_j = 150^\circ\text{C}$		24.6		mJ
		$T_j = 150^\circ\text{C}$				
$R_{th(j-c)}$	per IGBT				0.14	K/W
$R_{th(c-s)}$	per IGBT ($\lambda_{grease}=0.81\text{ W}/(\text{m}^*\text{K})$)			0.046		K/W
$R_{th(c-s)}$	per IGBT, pre-applied phase change material			0.036		K/W
IGBT2						
$V_{CE(sat)}$	$I_C = 200\text{ A}$ $V_{GE} = 15\text{ V}$ chipllevel	$T_j = 25^\circ\text{C}$		1.80	2.05	V
		$T_j = 150^\circ\text{C}$		2.20	2.40	V
V_{CE0}	chipllevel	$T_j = 25^\circ\text{C}$		0.80	0.90	V
		$T_j = 150^\circ\text{C}$		0.70	0.80	V
r_{CE}	$V_{GE} = 15\text{ V}$ chipllevel	$T_j = 25^\circ\text{C}$		5.0	5.8	m Ω
		$T_j = 150^\circ\text{C}$		7.5	8.0	m Ω
$V_{GE(th)}$	$V_{GE} = V_{CE}, I_C = 7.6\text{ mA}$		5	5.8	6.5	V
I_{CES}	$V_{GE} = 0\text{ V}, V_{CE} = 1200\text{ V}, T_j = 25^\circ\text{C}$				2.7	mA
C_{ies}	$V_{CE} = 25\text{ V}$ $V_{GE} = 0\text{ V}$	$f = 1\text{ MHz}$		12.3		nF
C_{oes}		$f = 1\text{ MHz}$		0.81		nF
C_{res}		$f = 1\text{ MHz}$		0.69		nF
Q_G	$V_{GE} = -8\text{ V...} + 15\text{ V}$			1130		nC
R_{Gint}	$T_j = 25^\circ\text{C}$			3.8		Ω
$t_{d(on)}$	$V_{CC} = 600\text{ V}$	$T_j = 150^\circ\text{C}$		85		ns
t_r	$I_C = 200\text{ A}$	$T_j = 150^\circ\text{C}$		57		ns
E_{on}	$V_{GE} = +15/-8\text{ V}$	$T_j = 150^\circ\text{C}$		8.4		mJ
$t_{d(off)}$	$R_{G\ on} = 0.5\ \Omega$	$T_j = 150^\circ\text{C}$		504		ns
t_f	$R_{G\ off} = 1\ \Omega$	$T_j = 150^\circ\text{C}$		120		ns
E_{off}	$di/dt_{on} = 3450\text{ A}/\mu\text{s}$ $di/dt_{off} = 1430\text{ A}/\mu\text{s}$ $du/dt = 3560\text{ V}/\mu\text{s}$	$T_j = 150^\circ\text{C}$		25.4		mJ
		$T_j = 150^\circ\text{C}$				
$R_{th(j-c)}$	per IGBT				0.16	K/W
$R_{th(c-s)}$	per IGBT ($\lambda_{grease}=0.81\text{ W}/(\text{m}^*\text{K})$)			0.052		K/W
$R_{th(c-s)}$	per IGBT, pre-applied phase change material			0.041		K/W



SEMiX® 5

3-Level NPC IGBT-Module

Engineering Sample

SEMiX205MLI12E4

Target Data

Features

- Solderless assembling solution with PressFIT signal pins and screw power terminals
- IGBT 4 Trench Gate Technology
- $V_{CE(sat)}$ with positive temperature coefficient
- Low inductance case
- Reliable mechanical design with injection moulded terminals and reliable internal connections
- UL recognized file no. E63532
- NTC temperature sensor inside

Remarks*

- Case temperature limited to $T_C=125^\circ\text{C}$ max.
- Product reliability results are valid for $T_{jop}=150^\circ\text{C}$
- IGBT1: outer IGBTs T1 & T4
- IGBT2: inner IGBTs T2 & T3
- Diode1: outer diodes D1 & D4
- Diode2: inner diodes D2 & D3
- Diode5: clamping diodes D5 & D6
- For storage and case temperature with TIM see document "TP(HALA P8) SEMiX 5p"

Characteristics						
Symbol	Conditions		min.	typ.	max.	Unit
Diode1						
$V_F = V_{EC}$	$I_F = 200\text{ A}$ $V_{GE} = 0\text{ V}$ chipelevel	$T_j = 25^\circ\text{C}$		2.20	2.52	V
		$T_j = 150^\circ\text{C}$		2.15	2.47	V
V_{F0}	chipelevel	$T_j = 25^\circ\text{C}$		1.30	1.50	V
		$T_j = 150^\circ\text{C}$		0.90	1.10	V
r_F	chipelevel	$T_j = 25^\circ\text{C}$		4.5	5.1	m Ω
		$T_j = 150^\circ\text{C}$		6.3	6.9	m Ω
I_{RRM}	$I_F = 200\text{ A}$	$T_j = 150^\circ\text{C}$		158		A
Q_{rr}	$di/dt_{off} = 3450\text{ A}/\mu\text{s}$ $V_{CC} = 600\text{ V}$	$T_j = 150^\circ\text{C}$		23.9		μC
E_{rr}	$V_{GE} = +15/-8\text{ V}$	$T_j = 150^\circ\text{C}$		5.2		mJ
$R_{th(j-c)}$	per diode				0.26	K/W
$R_{th(c-s)}$	per diode ($\lambda_{grease}=0.81\text{ W}/(\text{m}^*\text{K})$)			0.06		K/W
$R_{th(c-s)}$	per diode, pre-applied phase change material			0.051		K/W
Diode2						
$V_F = V_{EC}$	$I_F = 200\text{ A}$ $V_{GE} = 0\text{ V}$ chipelevel	$T_j = 25^\circ\text{C}$		2.20	2.52	V
		$T_j = 150^\circ\text{C}$		2.15	2.47	V
V_{F0}	chipelevel	$T_j = 25^\circ\text{C}$		1.30	1.50	V
		$T_j = 150^\circ\text{C}$		0.90	1.10	V
r_F	chipelevel	$T_j = 25^\circ\text{C}$		4.5	5.1	m Ω
		$T_j = 150^\circ\text{C}$		6.3	6.9	m Ω
I_{RRM}	$I_F = 200\text{ A}$	$T_j = 150^\circ\text{C}$		158		A
Q_{rr}	$V_R = 600\text{ V}$	$T_j = 150^\circ\text{C}$		23.9		μC
E_{rr}	$V_{GE} = +15/-8\text{ V}$	$T_j = 150^\circ\text{C}$		-		mJ
$R_{th(j-c)}$	per diode				0.29	K/W
$R_{th(c-s)}$	per diode ($\lambda_{grease}=0.81\text{ W}/(\text{m}^*\text{K})$)			0.067		K/W
$R_{th(c-s)}$	per diode, pre-applied phase change material			0.056		K/W
Diode5						
$V_F = V_{EC}$	$I_F = 200\text{ A}$ chipelevel	$T_j = 25^\circ\text{C}$		2.20	2.52	V
		$T_j = 150^\circ\text{C}$		2.15	2.47	V
V_{F0}	chipelevel	$T_j = 25^\circ\text{C}$		1.30	1.50	V
		$T_j = 150^\circ\text{C}$		0.90	1.10	V
r_F	chipelevel	$T_j = 25^\circ\text{C}$		4.5	5.1	m Ω
		$T_j = 150^\circ\text{C}$		6.3	6.9	m Ω
I_{RRM}	$I_F = 200\text{ A}$	$T_j = 150^\circ\text{C}$		185		A
Q_{rr}	$di/dt_{off} = 3610\text{ A}/\mu\text{s}$ $V_R = 600\text{ V}$	$T_j = 150^\circ\text{C}$		28.7		μC
E_{rr}	$V_{GE} = +15/-8\text{ V}$	$T_j = 150^\circ\text{C}$		12.46		mJ
$R_{th(j-c)}$	per diode				0.28	K/W
$R_{th(c-s)}$	per diode ($\lambda_{grease}=0.81\text{ W}/(\text{m}^*\text{K})$)			0.086		K/W
$R_{th(c-s)}$	per diode, pre-applied phase change material			0.069		K/W

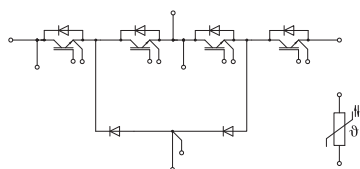

MLI

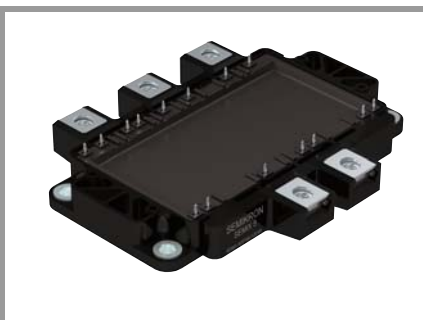

SEMiX® 5

3-Level NPC IGBT-Module

Engineering Sample

SEMiX205MLI12E4

Target Data

Features

- Solderless assembling solution with PressFIT signal pins and screw power terminals
- IGBT 4 Trench Gate Technology
- $V_{CE(sat)}$ with positive temperature coefficient
- Low inductance case
- Reliable mechanical design with injection moulded terminals and reliable internal connections
- UL recognized file no. E63532
- NTC temperature sensor inside

Remarks*

- Case temperature limited to $T_C=125^\circ\text{C}$ max.
- Product reliability results are valid for $T_{jop}=150^\circ\text{C}$
- IGBT1: outer IGBTs T1 & T4
- IGBT2: inner IGBTs T2 & T3
- Diode1: outer diodes D1 & D4
- Diode2: inner diodes D2 & D3
- Diode5: clamping diodes D5 & D6
- For storage and case temperature with TIM see document "TP(HALA P8) SEMiX 5p"

Characteristics							
Symbol	Conditions		min.	typ.	max.	Unit	
Module							
L_{sCE1}				27		nH	
L_{sCE2}				34		nH	
$R_{CC'+EE'}$	measured between terminal 5 and 1	$T_C = 25^\circ\text{C}$		0.8		m Ω	
		$T_C = 125^\circ\text{C}$		1.1		m Ω	
$R_{th(c-s)1}$	calculated without thermal coupling			0.006		K/W	
$R_{th(c-s)2}$	including thermal coupling, T_s underneath module ($\lambda_{grease}=0.81\text{ W}/(\text{m}^2\text{K})$)			0.0096		K/W	
	including thermal coupling, T_s underneath module, pre-applied phase change material			0.0078		K/W	
M_s	to heat sink (M5)		3		6	Nm	
M_t			to terminals (M6)		3	6	Nm
							Nm
W				398		g	
Temperature Sensor							
R_{100}	$T_C=100^\circ\text{C}$ ($R_{25}=5\text{ k}\Omega$)			$493 \pm 5\%$		Ω	
$B_{100/125}$	$R(T)=R_{100}\exp[B_{100/125}(1/T-1/T_{100})]$; $T[\text{K}]$;			$3550 \pm 2\%$		K	

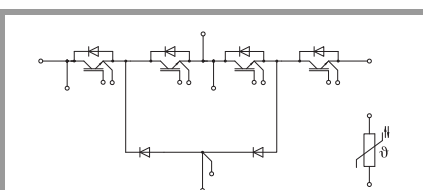

MLI

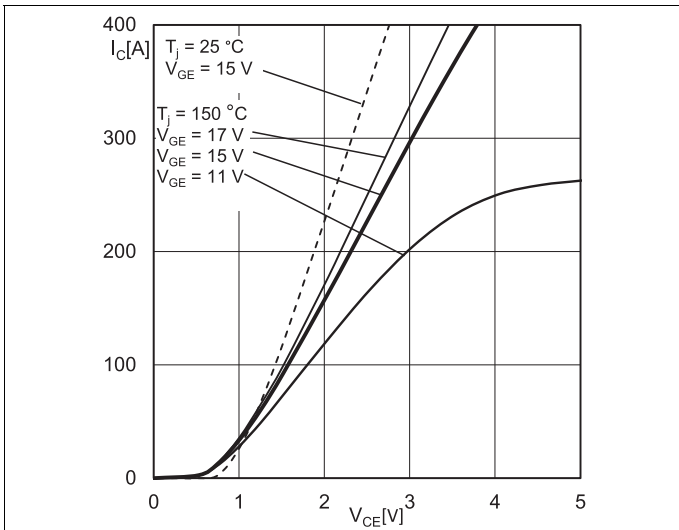

Fig. 1: Typ. IGBT1 output characteristic, incl. $R_{CC'+EE'}$

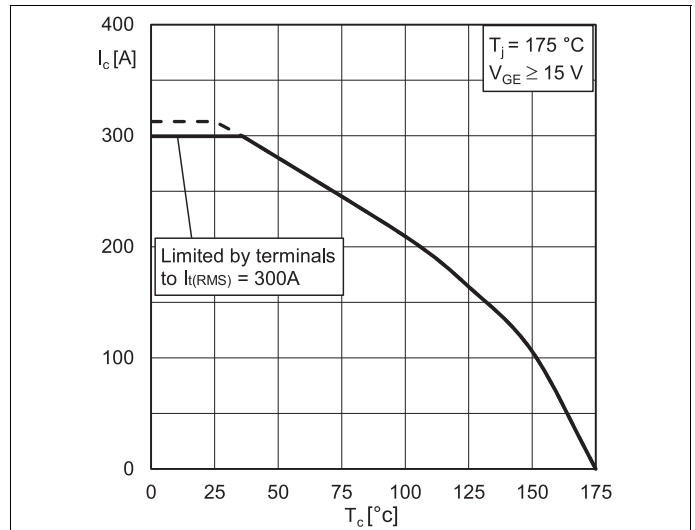

Fig. 2: IGBT1 rated current vs. Temperature $I_c=f(T_c)$

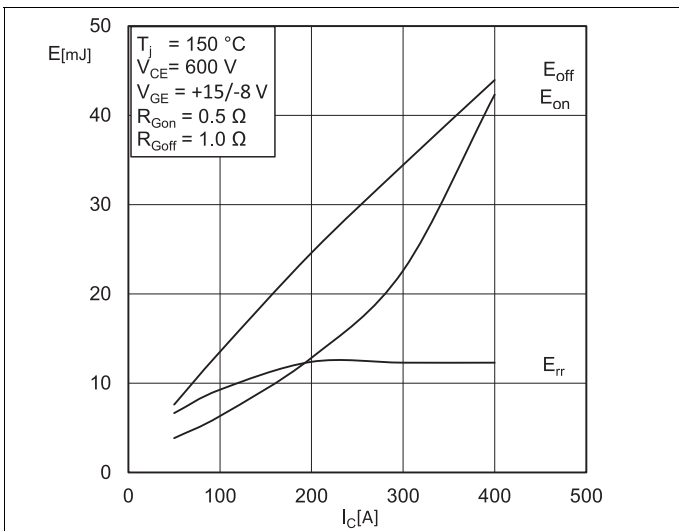

Fig. 3: Typ. IGBT1 & Diode5 turn-on /-off energy = $f(I_c)$

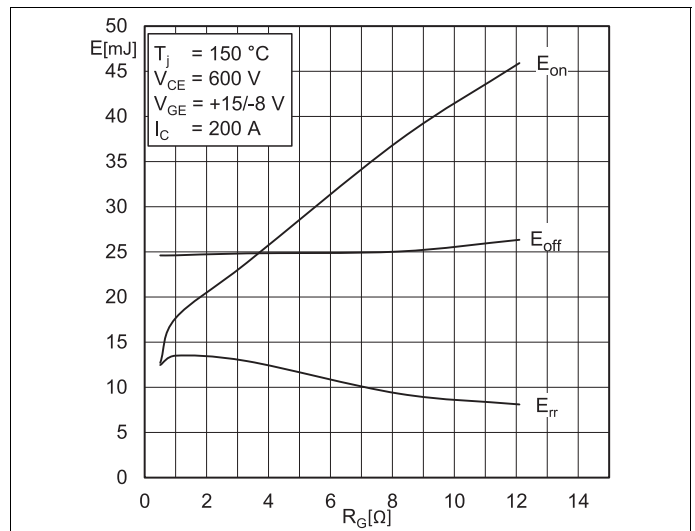

Fig. 4: Typ. IGBT1 & Diode5 turn-on /-off energy = $f(R_G)$

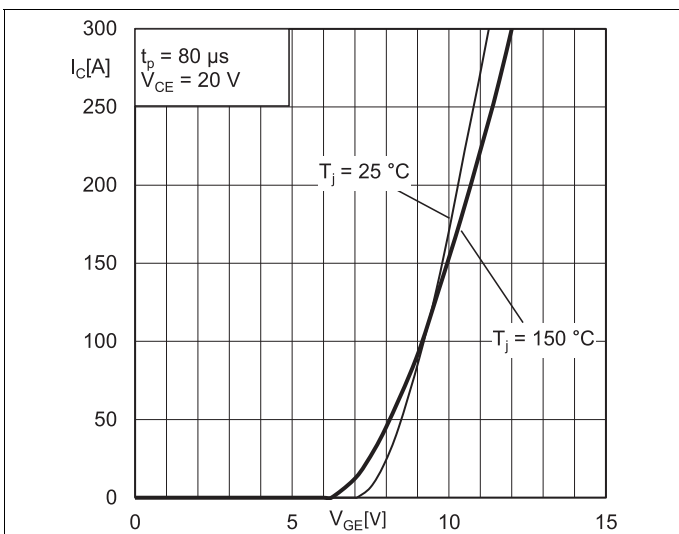

Fig. 5: Typ. IGBT1 transfer characteristic

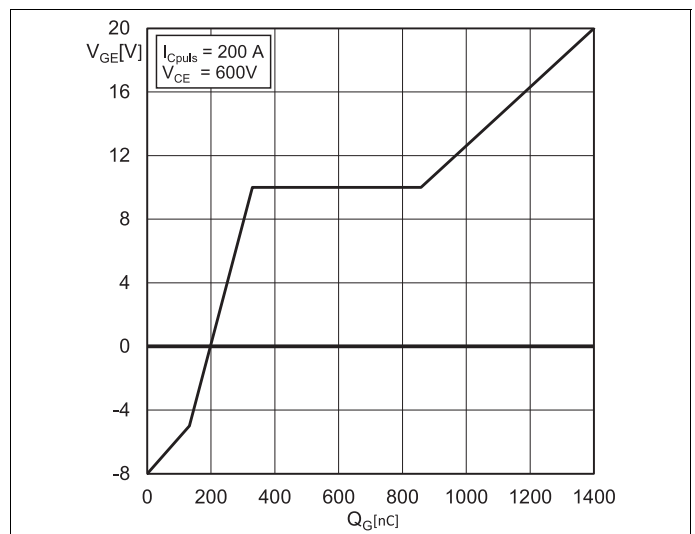

Fig. 6: Typ. IGBT1 gate charge characteristic

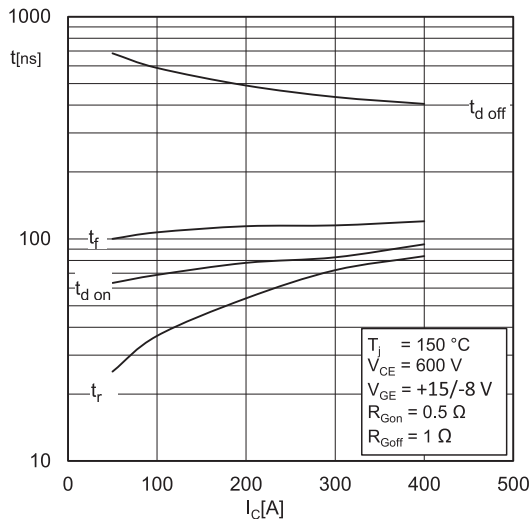

Fig. 7: Typ. IGBT1 switching times vs. I_c

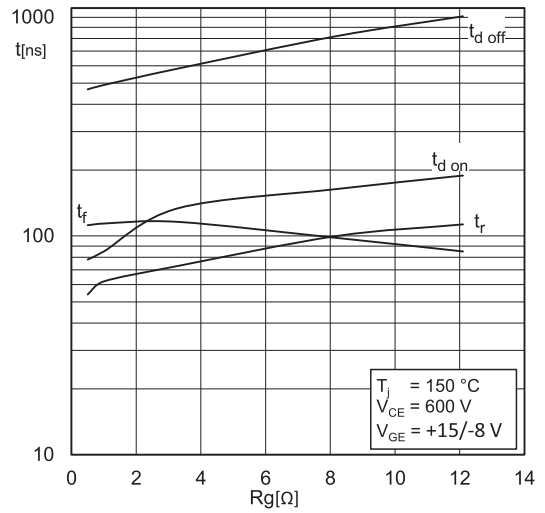

Fig. 8: Typ. IGBT1 switching times vs. gate resistor R_g

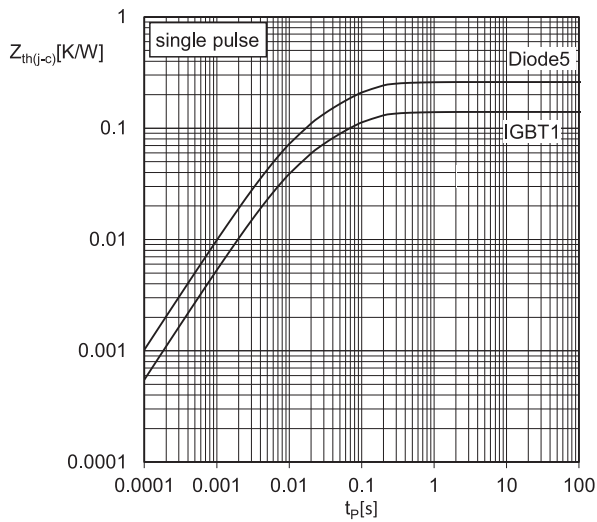

Fig. 9: Transient thermal impedance of IGBT1 & Diode5

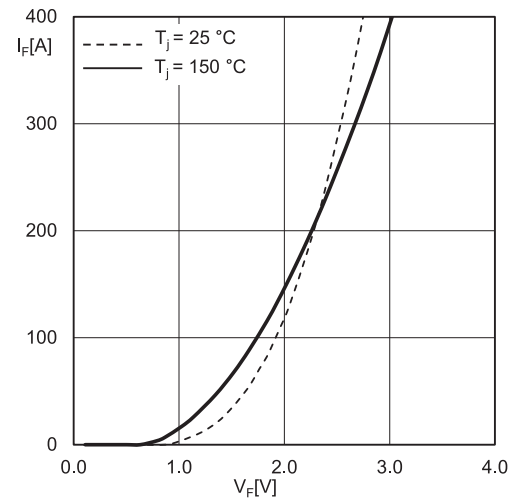

Fig. 10: Typ. Diode5 forward characteristic, incl. $R_{CC+EE'}$

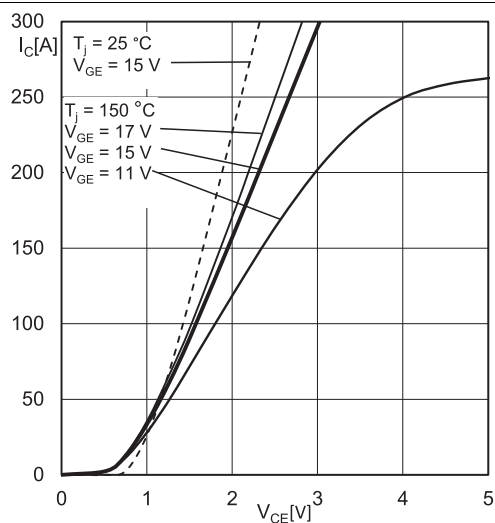

Fig. 13: Typ. IGBT2 output characteristic, incl. $R_{CC+EE'}$

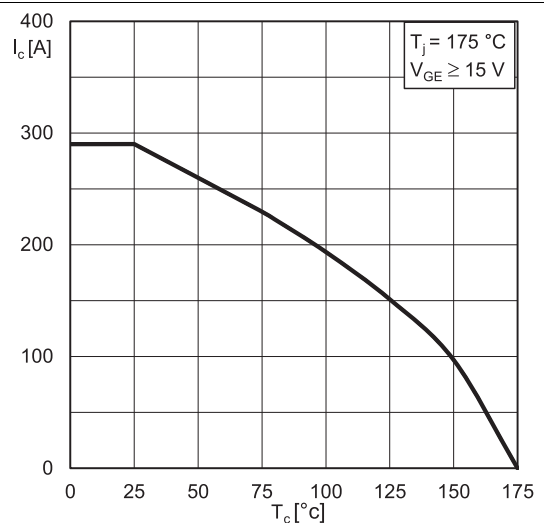

Fig. 14: IGBT2 rated current vs. Temperature $I_c = f(T_c)$

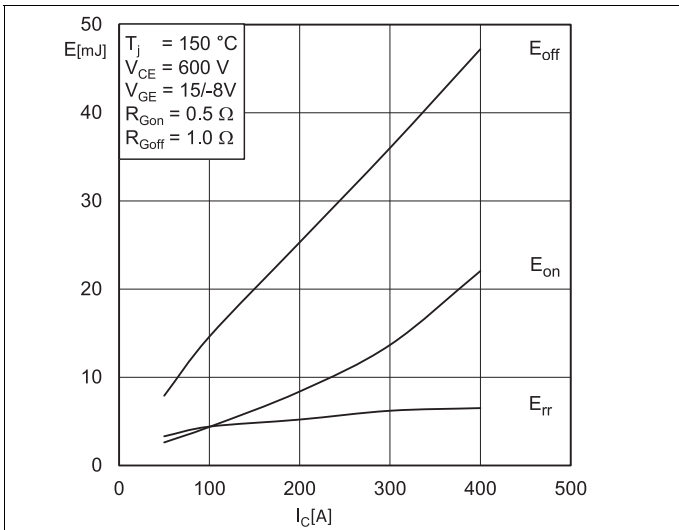

Fig. 15: Typ. IGBT2 & Diode1 turn-on /-off energy = $f(I_C)$

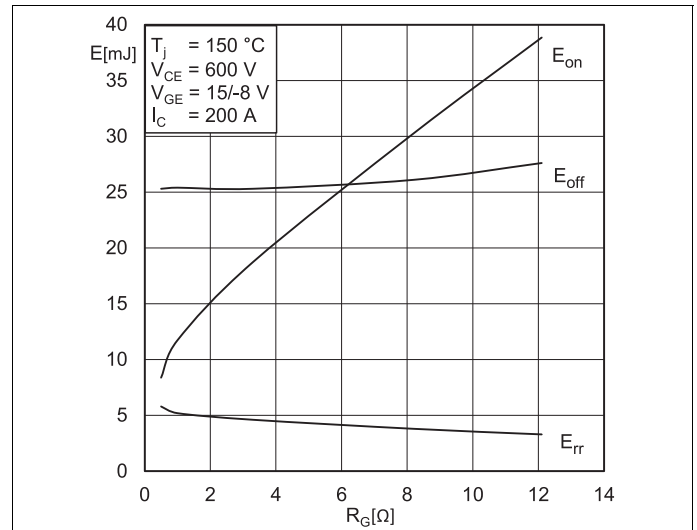

Fig. 16: Typ. IGBT2 & Diode1 turn-on / -off energy = $f(R_G)$

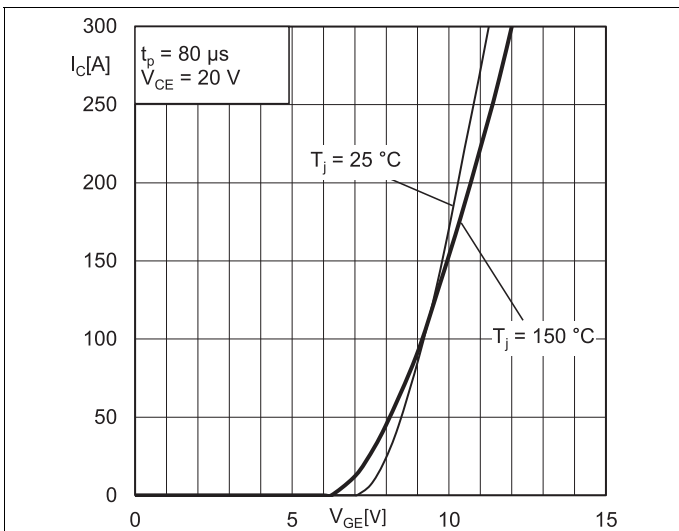

Fig. 17: Typ. IGBT2 transfer characteristic

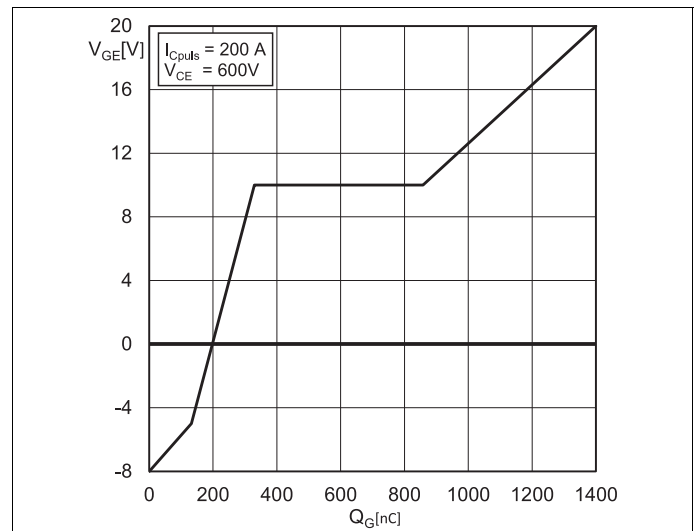

Fig. 18: Typ. IGBT2 gate charge characteristic

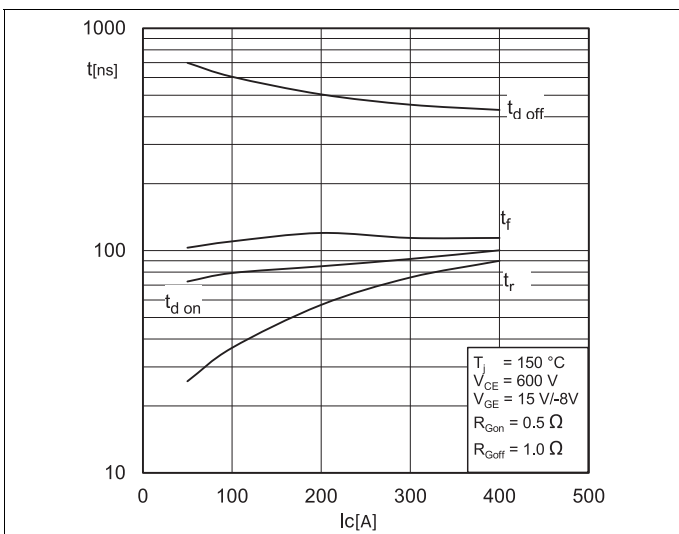

Fig. 19: Typ. IGBT2 switching times vs. I_C

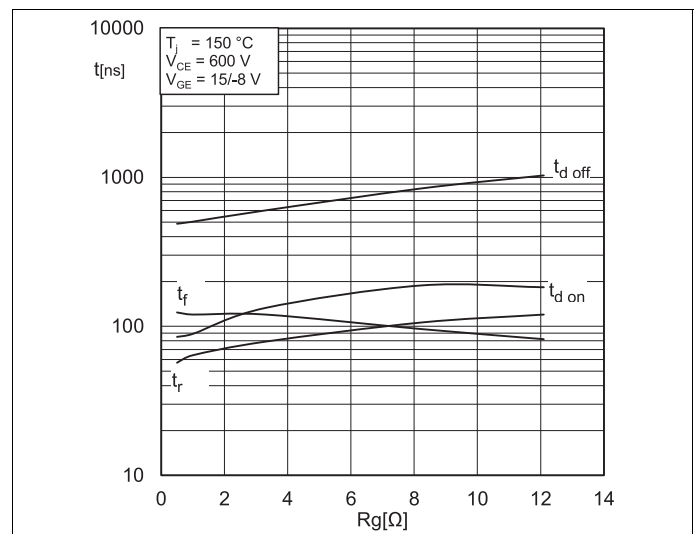

Fig. 20: Typ. IGBT2 switching times vs. gate resistor R_G

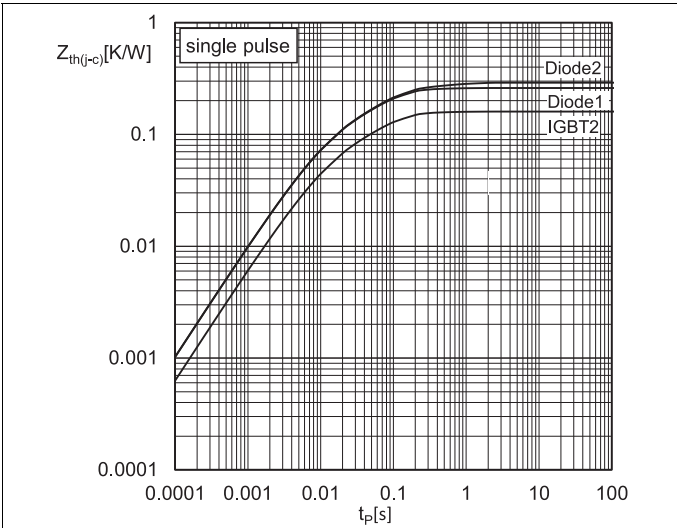

Fig. 21: Transient thermal impedance of IGBT2, Diode1 & Diode2

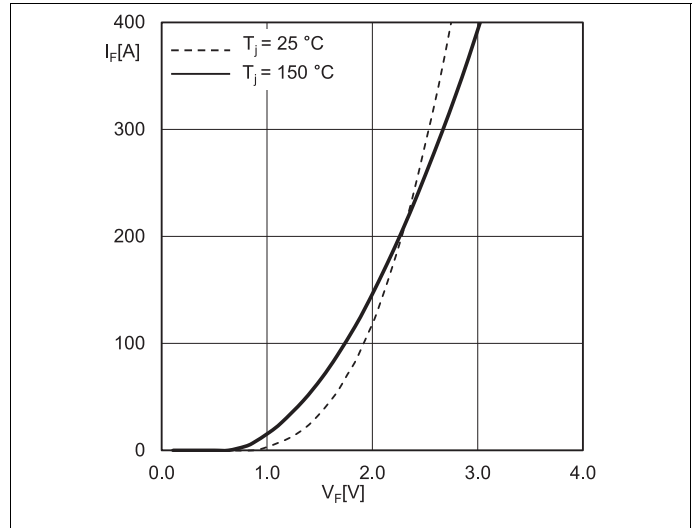
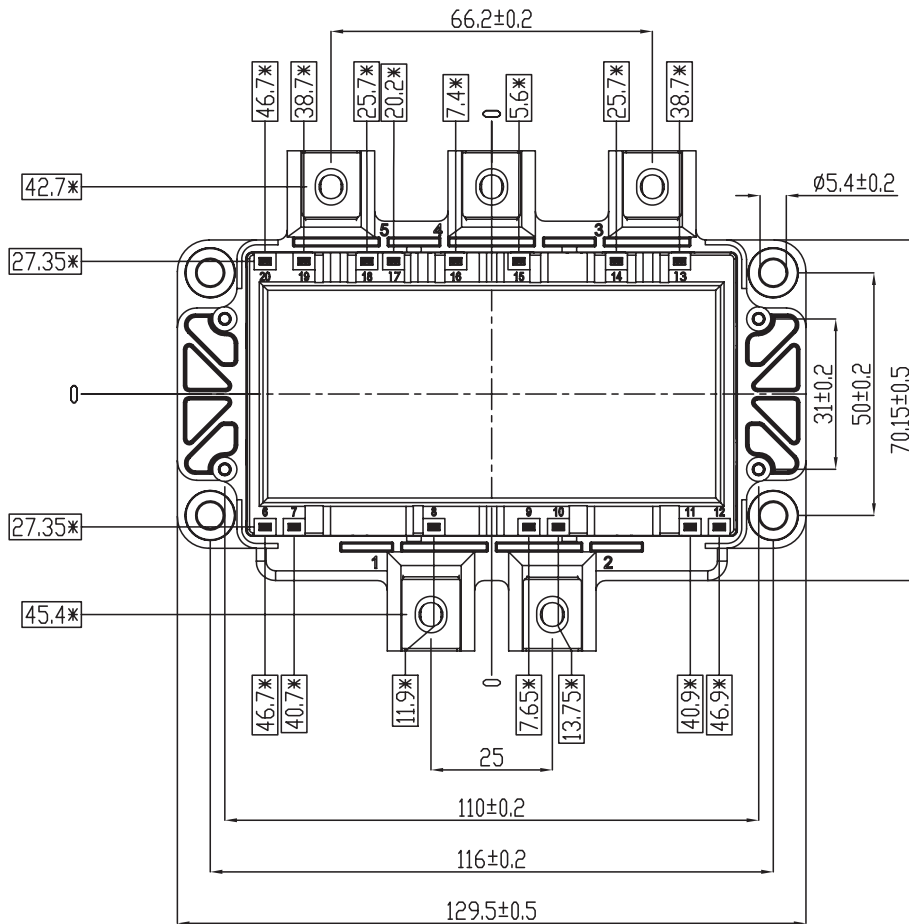
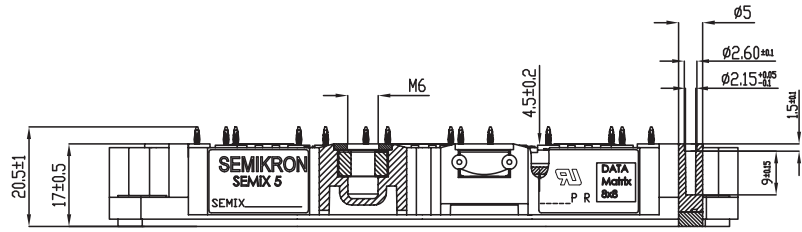

Fig. 22: Typ. Diode1 & Diode2 forward characteristic, incl. $R_{CC'+EE'}$

SEMiX205MLI12E4



* = All dimension with tolerance of ± 0.4

For technical details please refer to SEMiX(R)5 Mounting Instruction

SEMiX5p

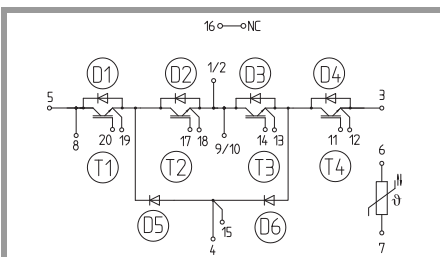

MLI

This is an electrostatic discharge sensitive device (ESDS), international standard IEC 60747-1, chapter IX.

***IMPORTANT INFORMATION AND WARNINGS**

The specifications of SEMIKRON products may not be considered as guarantee or assurance of product characteristics ("Beschaffenheitsgarantie"). The specifications of SEMIKRON products describe only the usual characteristics of products to be expected in typical applications, which may still vary depending on the specific application. Therefore, products must be tested for the respective application in advance. Application adjustments may be necessary. The user of SEMIKRON products is responsible for the safety of their applications embedding SEMIKRON products and must take adequate safety measures to prevent the applications from causing a physical injury, fire or other problem if any of SEMIKRON products become faulty. The user is responsible to make sure that the application design is compliant with all applicable laws, regulations, norms and standards. Except as otherwise explicitly approved by SEMIKRON in a written document signed by authorized representatives of SEMIKRON, SEMIKRON products may not be used in any applications where a failure of the product or any consequences of the use thereof can reasonably be expected to result in personal injury. No representation or warranty is given and no liability is assumed with respect to the accuracy, completeness and/or use of any information herein, including without limitation, warranties of non-infringement of intellectual property rights of any third party. SEMIKRON does not assume any liability arising out of the applications or use of any product; neither does it convey any license under its patent rights, copyrights, trade secrets or other intellectual property rights, nor the rights of others. SEMIKRON makes no representation or warranty of non-infringement or alleged non-infringement of intellectual property rights of any third party which may arise from applications. Due to technical requirements our products may contain dangerous substances. For information on the types in question please contact the nearest SEMIKRON sales office. This document supersedes and replaces all information previously supplied and may be superseded by updates. SEMIKRON reserves the right to make changes.

In accordance with the quality guidelines of SEMIKRON, we would like to point out that the products are engineering samples. These engineering samples are not yet produced under quality conditions approaching those of series production, and are at the present time not included in the SEMIKRON quality monitoring and control process. Neither the product nor the production process has to date gone completely through the SEMIKRON internal authorization procedure. SEMIKRON may make any amendments without any prior notification. SEMIKRON cannot and shall not promise or commit itself to release and/or make available a final version or series product after the development phase. SEMIKRON cannot and will not assume any responsibility with regard to freedom from defects, functionality, and adaptation to and interaction with possible applications of the user or with regard to any other potential risks resulting from the use of engineering samples. Therefore SEMIKRON explicitly excludes any warranty and liability; as far as legally possible. The customer shall fully indemnify and hold harmless SEMIKRON from any and all risks, damages, losses, expenses and costs directly or indirectly resulting out of or in connection with the commissioning, operation, system integration, sale, dissemination or any other kind of use of engineering samples by the customer and/or any third party, which has come into possession of engineering samples through or because of the customer. All know-how and all registerable and non-registerable copyrights and industrial property rights arising from or in connection with these engineering samples remain the exclusive property of SEMIKRON.