

SKiiP 11HEB066V1

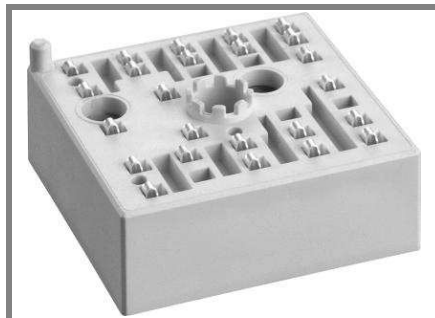

MiniSKiiP[®]1

1-phase half-controlled bridge rectifier + brake chopper + 3-phase bridge inverter

SKiiP 11HEB066V1

Features

- Trench IGBTs
- Robust and soft freewheeling diode in CAL technology
- Highly reliable spring contacts for electrical connection
- UL recognised file no. E63532

Remarks

- Case temperature limited to $T_C = 125^\circ\text{C}$
- Product reliability results are valid for $T_j = 150^\circ\text{C}$
- SC data: $t_p \leq 6 \text{ s}$; $V_{GE} = 15 \text{ V}$; $T_j = 150^\circ\text{C}$; $V_{CC} = 360 \text{ V}$
- V_{CEsat} , V_F , V_T = chip level value

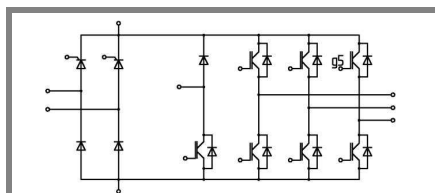

HEB

Absolute Maximum Ratings		$T_S = 25^\circ\text{C}$, unless otherwise specified	
Symbol	Conditions	Values	Units
IGBT - Inverter, Chopper			
V_{CES}		600	V
I_C	$T_S = 25 (70)^\circ\text{C}$, $T_j = 150^\circ\text{C}$	25 (17)	A
I_C	$T_S = 25 (70)^\circ\text{C}$, $T_j = 175^\circ\text{C}$	27 (21)	A
I_{CRM}	$t_p = 1 \text{ ms}$	30	A
V_{GES}		± 20	V
T_j		-40...+175	$^\circ\text{C}$
Diode - Inverter, Chopper			
I_F	$T_S = 25 (70)^\circ\text{C}$, $T_j = 150^\circ\text{C}$	24 (16)	A
I_F	$T_S = 25 (70)^\circ\text{C}$, $T_j = 175^\circ\text{C}$	28 (21)	A
I_{FRM}	$t_p = 1 \text{ ms}$	30	A
T_j		-40...+175	$^\circ\text{C}$
Diode / Thyristor - Rectifier			
V_{RRM}		800	V
I_F / I_T	$T_S = 70$	46 / 45	A
I_{FSM} / I_{TSM}	$t_p = 10 \text{ ms}$, $\sin 180^\circ$, $T_j = 25^\circ\text{C}$	370 / 340	A
i^2t	$t_p = 10 \text{ ms}$, $\sin 180^\circ$, $T_j = 25^\circ\text{C}$	575	A^2s
T_j	Diode	-40...+150	$^\circ\text{C}$
T_j	Thyristor	-40...+125	$^\circ\text{C}$
I_{tRMS}	per power terminal (20 A / spring)	20	A
T_{stg}	$T_{op} \leq T_{stg}$	-40...+125	$^\circ\text{C}$
V_{isol}	AC, 1 min.	2500	V

Characteristics		$T_S = 25^\circ\text{C}$, unless otherwise specified			
Symbol	Conditions	min.	typ.	max.	Units
IGBT - Inverter, Chopper					
V_{CEsat}	$I_{Cnom} = 15 \text{ A}$, $T_j = 25 (150)^\circ\text{C}$	1,45 (1,65)	1,85 (2,05)		V
$V_{GE(th)}$	$V_{GE} = V_{CE}$, $I_C = 1 \text{ mA}$		5,8		V
$V_{CE(TO)}$	$T_j = 25 (150)^\circ\text{C}$	0,9 (0,85)		1 (0,9)	V
r_T	$T_j = 25 (150)^\circ\text{C}$		40 (56,7)	60 (80)	$\text{m}\Omega$
C_{res}	$V_{CE} = 25 \text{ V}$, $V_{GE} = 0 \text{ V}$, $f = 1 \text{ MHz}$		0,86		nF
C_{oes}	$V_{CE} = 25 \text{ V}$, $V_{GE} = 0 \text{ V}$, $f = 1 \text{ MHz}$		0,18		nF
C_{res}	$V_{CE} = 25 \text{ V}$, $V_{GE} = 0 \text{ V}$, $f = 1 \text{ MHz}$		0,12		nF
$R_{CC+EE'}$	spring contact-chip $T_S = 25 (150)^\circ\text{C}$				$\text{m}\Omega$
$R_{th(j-s)}$	per IGBT		1,8		K/W
$t_{d(on)}$	under following conditions		20		ns
t_r	$V_{CC} = 300 \text{ V}$, $V_{GE} = \pm 15 \text{ V}$		30		ns
$t_{d(off)}$	$I_{Cnom} = 15 \text{ A}$, $T_j = 150^\circ\text{C}$		155		ns
t_f	$R_{Gon} = R_{Goff} = 22 \Omega$		45		ns
$E_{on} (E_{off})$	inductive load		0,6 (0,5)		mJ
Diode - Inverter, Chopper					
$V_F = V_{EC}$	$I_{Fnom} = 15 \text{ A}$, $T_j = 25 (150)^\circ\text{C}$	1,4 (1,4)	1,7 (1,7)		V
$V_{(TO)}$	$T_j = 25 (150)^\circ\text{C}$	1 (0,9)	1,1 (1)		V
r_T	$T_j = 25 (150)^\circ\text{C}$		27 (34)	40 (47)	$\text{m}\Omega$
$R_{th(j-s)}$	per diode		2,46		K/W
I_{RRM}	under following conditions		20		A
Q_{rr}	$I_{Fnom} = 15 \text{ A}$, $V_R = 300 \text{ V}$		2		C
E_{rr}	$V_{GE} = 0 \text{ V}$, $T_j = 150^\circ\text{C}$		0,5		mJ
	$di_F/dt = 930 \text{ A/s}$				

Characteristics		$T_S = 25^\circ\text{C}$, unless otherwise specified			
Symbol	Conditions	min.	typ.	max.	Units
Diode - Rectifier					
V_F	$I_{Fnom} = 25\text{ A}, T_j = 25^\circ\text{C}$		1,1		V
$V_{(TO)}$	$T_j = 150^\circ\text{C}$		0,8		V
r_T	$T_j = 150^\circ\text{C}$		13		m Ω
$R_{th(j-s)}$	per diode		1,25		K/W
Thyristor - Rectifier					
V_T	$I_{Fnom} = 25\text{ A}, T_j = 25\text{ (125)}^\circ\text{C}$			(1,6)	V
$V_{T(TO)}$	$T_j = 125^\circ\text{C}$			1,1	V
r_T	$T_j = 125^\circ\text{C}$			20	m Ω
V_{GT}	$T_j = 25^\circ\text{C}$			2	V
I_{GT}	$T_j = 25^\circ\text{C}$			100	mA
I_H	$T_j = 25^\circ\text{C}$		80	150	mA
I_L	$T_j = 25^\circ\text{C}$		150	300	mA
$dv/dt_{(cr)}$	$T_j = 125^\circ\text{C}$	500			V/ s
$di/dt_{(cr)}$	$T_j = 125^\circ\text{C}$			100	A/ s
$R_{th(j-s)}$	per thyristor		1,25		K/W
Temperature Sensor					
R_{ts}	3 %, $T_r = 25\text{ (100)}^\circ\text{C}$		1000(1670)		Ω
Mechanical Data					
w			35		g
M_s	Mounting torque	2		2,5	Nm

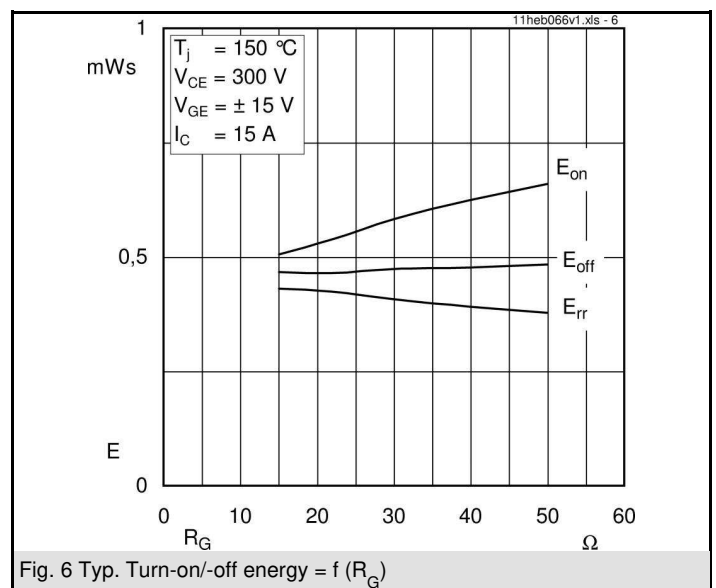
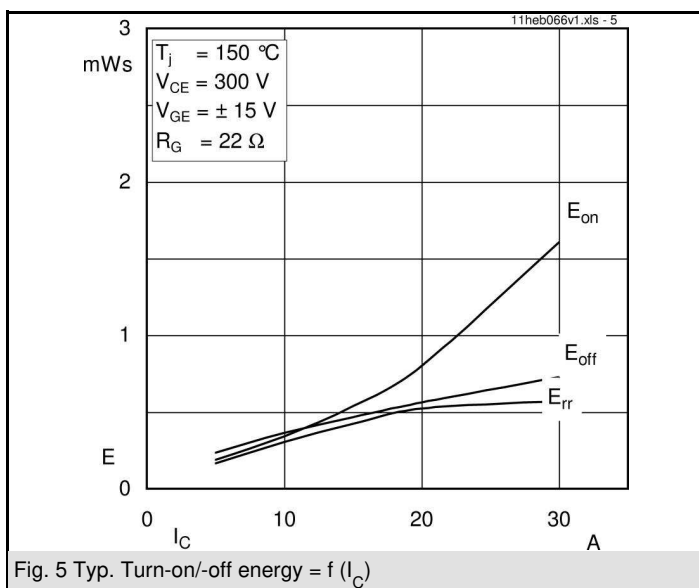
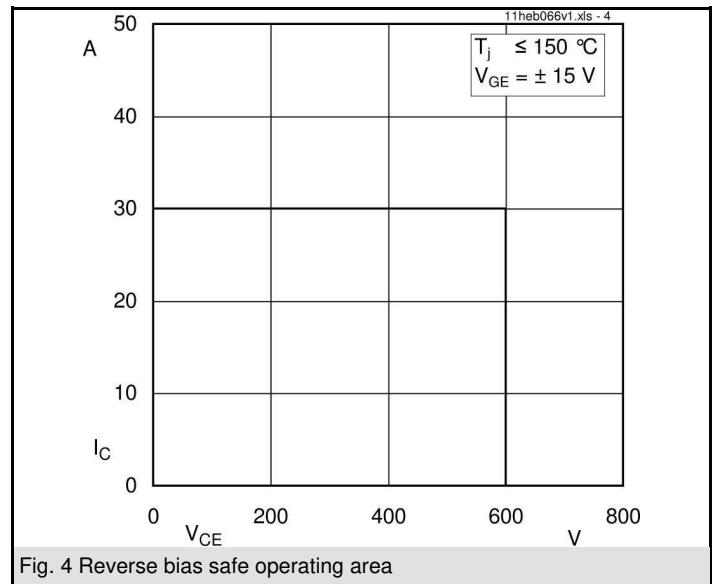
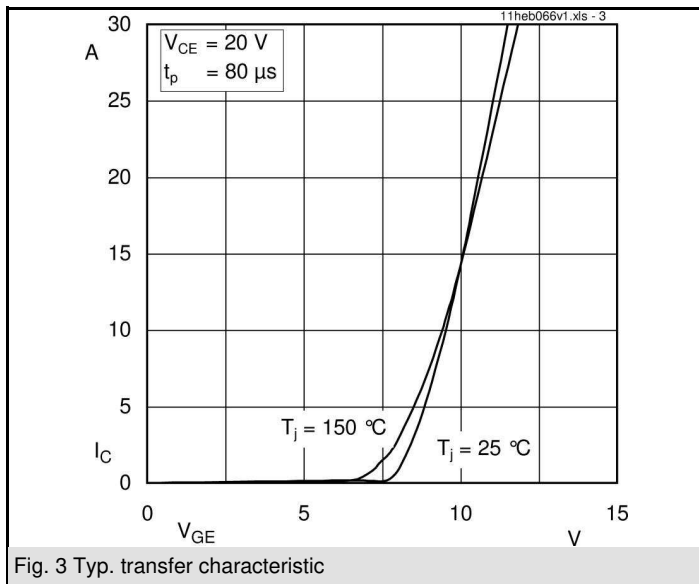
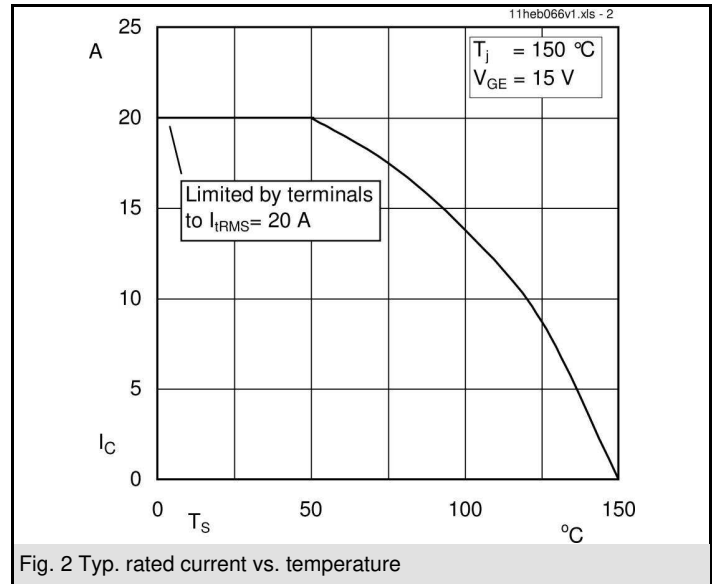
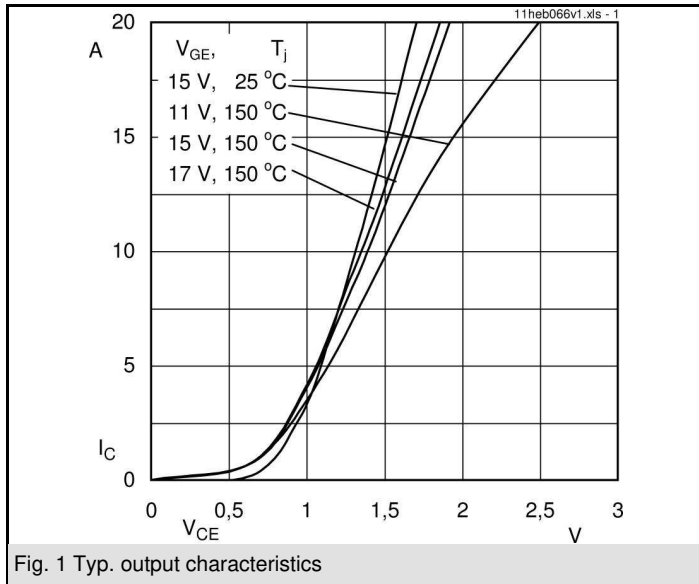

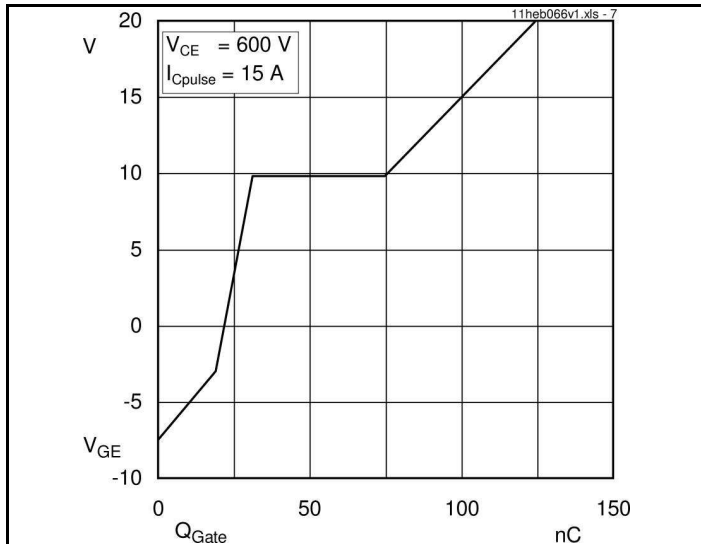

Fig. 7 Typ. gate charge characteristic

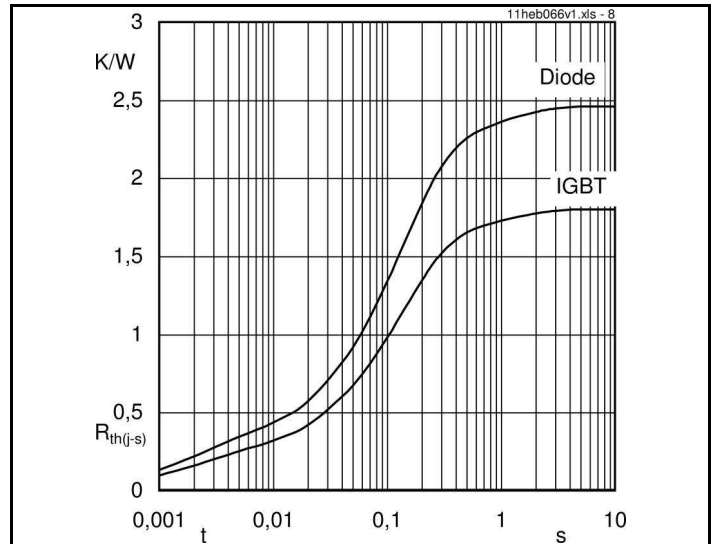

Fig. 8 Typ. thermal impedance

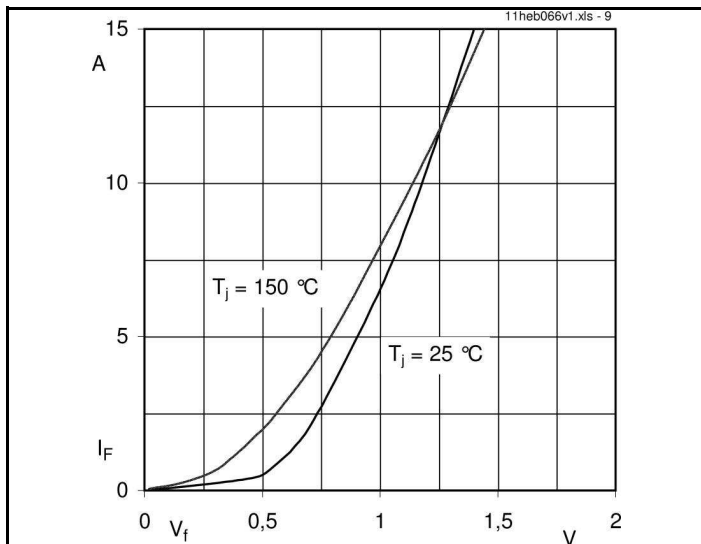

Fig. 9 Typ. freewheeling diode forward characteristic

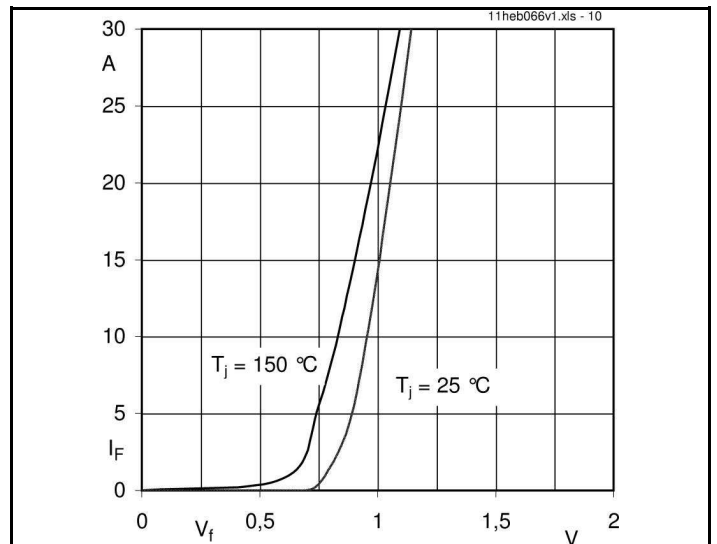

Fig. 10 Typ. input bridge forward characteristic (rect. diode)

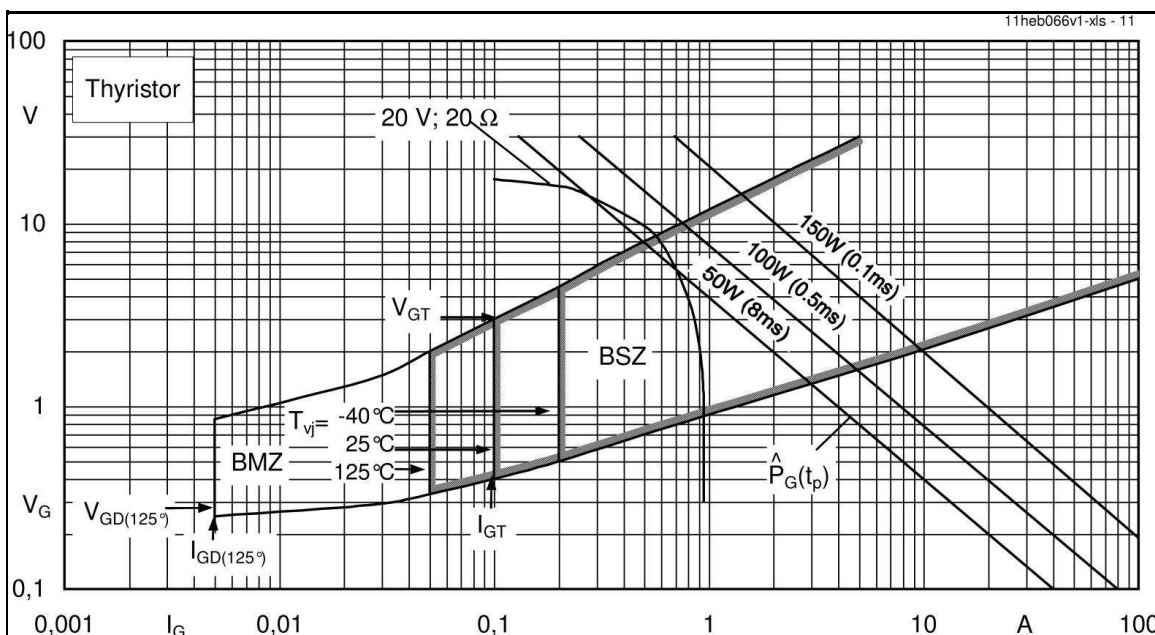
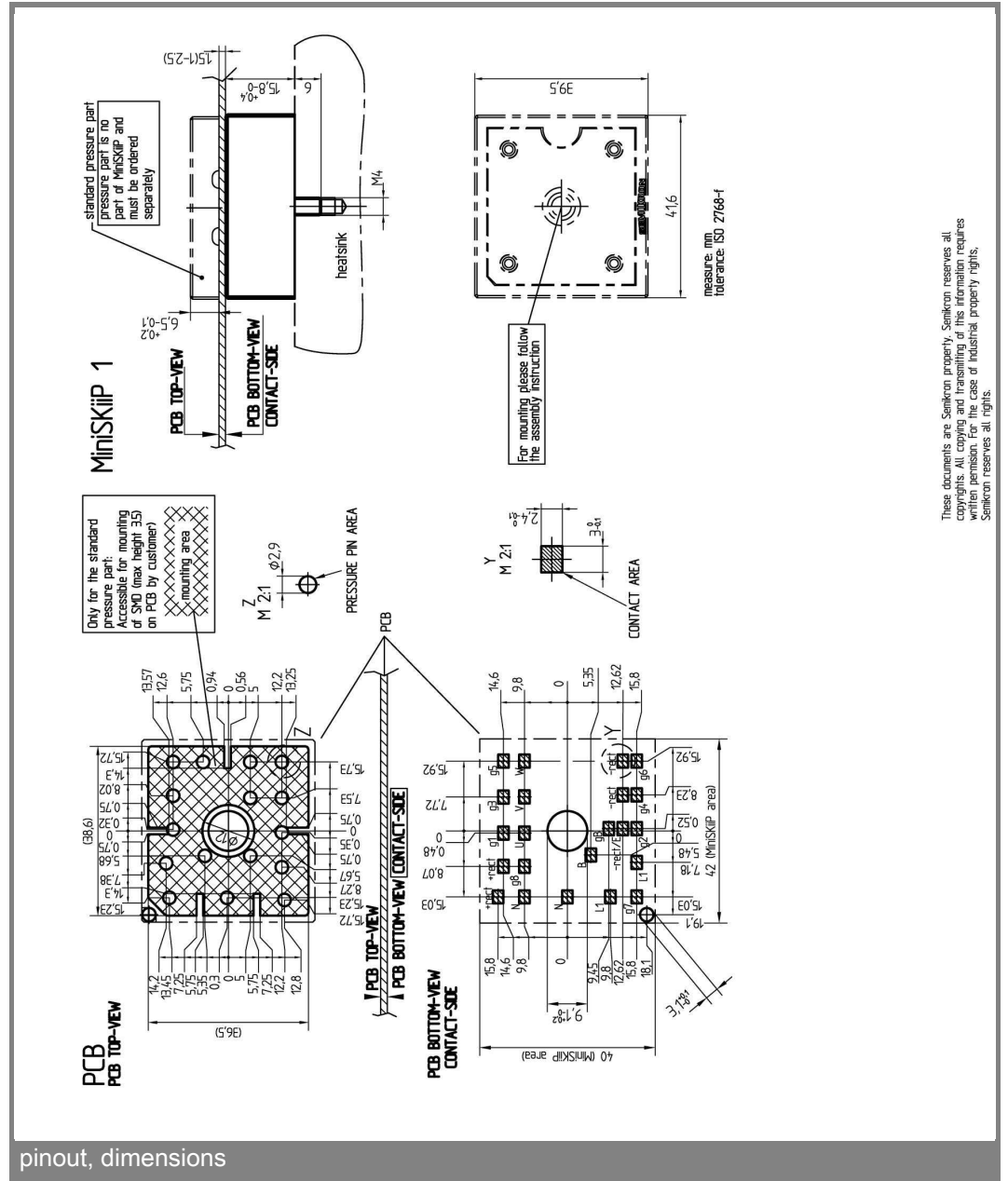
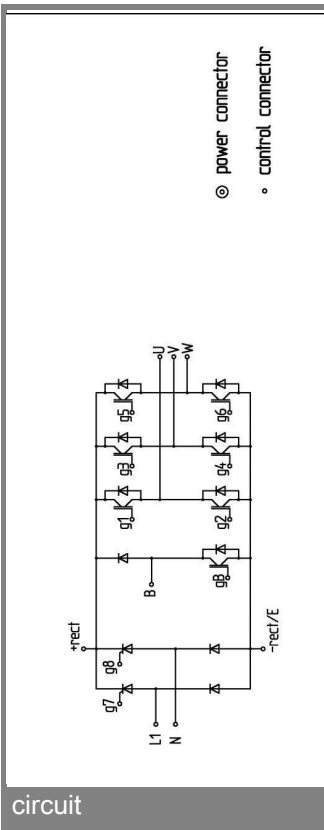

Fig. 11 gate trigger characteristics



These documents are Semikron property. Semikron reserves all copyrights. All copying and transmitting of this information requires written permission. For the case of industrial property rights, Semikron reserves all rights.

This is an electrostatic discharge sensitive device (ESDS), international standard IEC 60747-1, Chapter IX.

* The specifications of our components may not be considered as an assurance of component characteristics. Components have to be tested for the respective application. Adjustments may be necessary. The use of SEMIKRON products in life support appliances and systems is subject to prior specification and written approval by SEMIKRON. We therefore strongly recommend prior consultation of our personal.